

Investigation of the Friction Factor-Reynolds Number Relationship for Flow through Packed Beds

Zainab Talib Abdzaid

Al-Mustansiriyah University/College of
Engineering
Environmental Engineering Department

Abstract

This work presents the study of water flow through a packed bed containing spherical glass particles distributed randomly. The packed bed was 7.62 cm in diameter and 57 cm long. The glass particles were 0.42, 0.50, 0.61, 0.79 and 1.01 cm in diameter. Different flow rates of fluid were used which expressed by modified Reynolds number. The experiments were carried out at laboratory temperatures at city water temperature (25°C) for water flow. Many variables were studied in this work such as fluid type, flow rate and the packing porosity, in order to study the effect of these variables on the pressure drop and friction factor. The results showed that the pressure drop through a packed bed is highly sensitive to the packing porosity which has a significant effect on the friction factor. It was found that as the bed porosity increases the friction factor values as well as the pressure drop values decrease.

Empirical correlation for friction factor as a function of Reynolds number for water flow through packed of mono size packing has been made, and can be written as follows:

$$f = 3.51Re_1^{-1} + 0.53Re_1^{-0.1}$$

The correlation coefficient was 0.97406 and percentage of average errors was 2.44%.

معادلات دراسة العلاقة بين معامل الاحتكاك ورقم رينولدز لجريان الماء خلال العمود الحشوي

زينب طالب عبد زيد

الجامعة المستنصرية /كلية الهندسة/قسم هندسة البيئة

الخلاصة

يتضمن هذا البحث دراسة جريان الماء خلال عمود حشوي المحشو بجسيمات زجاجية كروية الحجم وموزعة بشكل عشوائي. وقد كان قطر العمود المحشو 7.62cm وطوله 57cm. وكان قطر الكريات الزجاجية 0.42, 0.50, 0.61, 0.79 and 1.01 cm. كما استخدمت عدة سرع لمعدل الجريان للموائع المثل بعدد رينولدز (modified Reynolds number). لقد أجريت التجارب عند درجة حرارة ماء المدينة (25°C). لقد تم دراسة عدة عوامل خلال هذا العمل كمساحة المائع، سرعة الجريان وتغير مسامية الحشوة لمعرفة تأثير هذه العوامل على هبوط الضغط ومعامل الاحتكاك. اثبتت النتائج ان هبوط الضغط خلال عمود حشوي يتأثر لدرجة كبيرة بمسامية الحشوة والتي لها تأثير ملموس على معامل الاحتكاك. حيث لوحظ انه عندما تزداد مسامية الحشوة تقل قيم معامل الاحتكاك، وبالتالي تقل قيمة هبوط الضغط. العلاقات تجريبية لمعامل الاحتكاك بدلالة عدد رينولدز لجريان الماء خلال العمود الحشوي لحشوة احادية الشكل هي:

$$f = 3.51Re_1^{-1} + 0.53Re_1^{-0.1}$$

كان معامل التصحيح 0.97406 وكانت نسبة الخطأ 2.44%

1. Introduction

Fluid flow through packed bed has many important applications in chemical and other process engineering fields such as fixed-catalytic reactor, adsorption of a solute, gas absorption,

combustion, drying, filter bed, wastewater treatment and the flow of crude oil in petroleum reservoir [1]. A typical packed bed is a cylindrical column that is filled with a suitable packing material. The packing material may be spheres, cylinders, irregular particles or various kinds of commercial packing. It should have a large void volume to allow flow of fluid without excessive pressure drop and be chemically inert to fluids being processed [2]. One of the problems concerning the flow of fluids through beds of particles is the manner in which the particles are packed and the distribution of voids within the packed bed [3]. The particles packed together to form a structure which depends on a large number of parameters many of them are difficult to measure, or even to define. These include the shape and size distribution of particles, the way the packing has put together and the various forces exerted on it afterward [4].

The porosity has a great effect on the properties of granular media. There is no doubt that any small change in porosity of the bed leads to a big change in pressure drop across the bed. Leva in 1951 [5] found that a 1% decrease in the porosity of the bed produced about an 8% increase in the pressure drop, whilst Carman in 1937 [6] reported a higher value, 10% increase in the pressure drop for every 1% decrease in porosity.

The flow of fluids through beds composed either of irregularly shaped materials, or of packing of regular geometrical form has attracted considerable attention from many investigators (Kozeny in 1927 [7], Carman in 1937 [6], Coulson in 1949 [8], Blank in 1962 [9], Green and Ampts in 1962 [10]) studied the flow of air through columns packed with spherical materials. The packing of solid particles has been studied more or less continuously for a number of years [11]. The first study of the modes of packing of spheres appears to have been undertaken by Furnas in 1931 [12] studied the packing of a bed of different sizes solid particles. Westman and Hugill in 1930 [13] studied the packing of spheres led to the much-quoted limits of porosity for regular packing of single-size spheres.

The most important issue for mechanical perspective for liquid or gas flow through packed bed depends on the pressure drop and friction [14]. Hagen in 1839 carried out the first carefully documented friction experiments in low-speed tube laminar flow, from which the Hagen-Poiseuille law arose, this law experimentally derived in 1838 from the Darcy's law, formulated and published in 1840 and 1846. Poiseuille's law or the Hagen-Poiseuille law is a physical law concerning the voluminal laminar stationary flow of Newtonian fluid through a cylindrical tube with constant circular cross-section [15]. The friction factor is determined for the entire Reynolds number. For $Re < 10$ the flow through packed bed is laminar, the range $10 < Re < 100$ is commonly referred to as transitional whereas flows characterized by $Re > 100$ are considered turbulent [16]. Amount of work has been done in correlating data for packed columns at higher fluid velocities where the pressure drop appears to vary with some power of the velocity, the exponent ranging between 1 and 2. Blanke in 1962 [9] suggested that this change of relationship between pressure drop and velocity is entirely analogous to that which occurs in ordinary pipes and proposed a friction factor plot similar to that of commonly friction factor of Stanton. The equation used was that for kinetic effect modified by a friction factor, which is a function of Reynolds number [17].

$$\Delta p = 2f (\rho u^2 / d_p) \quad (1)$$

$$f = \phi (Re_1) \quad (2)$$

Some workers have included the effect of void fraction by the addition of another factor in equation 2. It is usually given in the form $(1-\epsilon)^m / \epsilon^3$ where m is either 1 or 2.

Carman and Kozeny in 1938 [6] suggested that the change of relationship between void fraction, pressure drop and velocity, and proposed a friction factor for entire Reynolds number by plotting on a logarithmic basis [18].

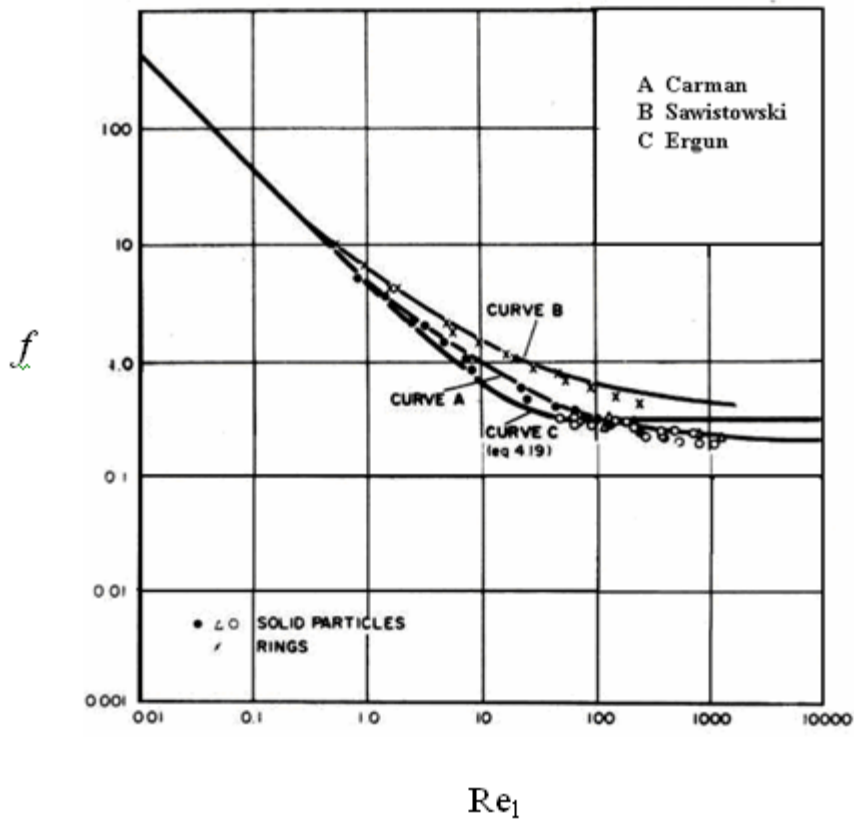

Fig. 1. Friction factor versus Reynolds number [19].

Figure 1 is a correlation of the friction factor as a function of the Reynolds number for condition of fixed bed operation. This figure was found to work satisfactorily for constant diameter fractions of the glass spheres. Carman in 1938 correlated data for flow through randomly packed beds of solid particles by a single curve (curve A, Fig. 1), whose general equation was:

$$f = 5 Re_1^{-1} + 0.4 Re_1^{-0.1} \tag{3}$$

where Re_1 is the modified Reynolds number and can be expressed in the following equation:

$$Re_1 = \frac{\rho u}{S(1-e)\mu} \tag{4}$$

and S is the specific surface area of the particles and is the surface area of particle divided by its volume. Its units are $(\text{length})^{-1}$. For sphere:

$$S = \frac{\pi d_p^2}{\pi \left(d_p^3 / 6 \right)} = \frac{6}{d_p} \tag{5}$$

Sawistowski in 1957 [20] has compared the results obtained for flow of fluids through beds of hollow packing and has noted that equation 3 gives lower values of friction factor for hollow packing. Thus, Sawistowski modified equation 3 as:

$$f = 5 Re_1^{-1} + Re_1^{-0.1} \tag{6}$$

Equation 6 is represented as curve B in Fig. 1.

Ergun in 1952 [21] suggested equation for flow through ring packings as:

$$f = 4.17 Re_1^{-1} + 0.29 \tag{7}$$

Equation 7 is plotted as curve C in Fig. 1.

As shown in Figure 1, the first term of equations 3, 6 and 7 predominates at low rates of flow ($Re < 10$) where the losses are mainly skin friction and the second term is small. At high flow rates ($2 < Re < 100$), the second term becomes more significant and the slope of the plot gradually changes from -1.0 to about -1/4. At higher flow rates ($Re > 100$) the plot is approximately straight. The change from complete streamline flow to complete turbulent flow is very gradual because flow conditions are not the same in all the pores [19].

The aim of this work is to:

- I. Study the effect of particles size and size distribution on the bed
- II. Study the effect of bed porosity on the pressure drop and friction factor through packed bed.
- III. Study the effect of the fluid flow (water) on the pressure drop and friction factor through packed bed.

Propose empirical correlations between friction factor and Reynolds number for air and water flow through packed bed.

2. Experimental Setup and Method

In this work five sizes of spherical glass particles were used. The spherical particles diameters were 0.42, 0.51, .61, 0.79 and 1.01cm. The fluid used was water, the properties was taken at city temperature (25°C) for water flow. The physical property of water at this temperature is density 997.07 kg/m^3 and viscosity $0.89 \times 10^{-3} \text{ kg/m.s}$ [22].

A schematic diagram of the apparatus used is shown in Figure 2, and photographic pictures for water flow are shown in figure 3. The packed bed column was made of glass tube (Q.V.F) 7.62 cm inside diameter and 57 cm height. The Q.V.F glass contains two pressure taps. The pressure taps were chosen to be small in diameter (2 mm) and inserted flush to the inside wall of the tube to avoid fluid turbulence and determine the static pressure accurately. The first tap was placed downstream at a distance of 1 cm from the sieve, and the second was placed at a distance of 1cm from the top of the packing. The distance between the inlet of the column and the sieve (packing rest) was 25 cm to avoid fluid turbulence at the bed inlet.

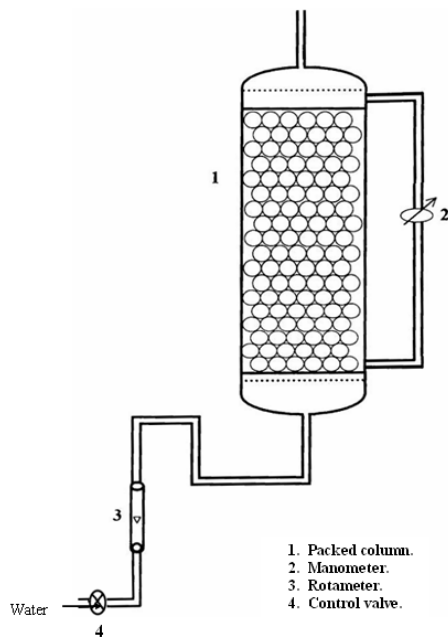

Fig. 2. Apparatus diagram.



Fig. 3. Photographic picture of water flow through packed bed.

The water flow system consists of a glass (Q.V.F) storage tank with capacity of 100 liter is used to provide water for pumping, centrifugal pump with power of 1.5 kW is used for pumping water from the storage tank to the test section, rotameter is used for measuring water flow rate with range up to 5 cubic meters per hour and U-tube manometer (with mercury) is used for measuring the pressure drop across the bed.

3. Experimental Procedure

The particles were poured into the column and the bed porosity was determined using the following equation [23].

$$\varepsilon = 1 - \frac{\rho_b}{\rho_t} \quad (8)$$

where ρ_t is the true density of the particles, (g/cm^3) and ρ_b is the apparent bulk density, (g/cm^3)

The fluid used was water provided by the pump and its flow rates were up to 5 cubic meters per hour, and its flow was controlled by means of a control valve at the inlet of the rotameter. The average velocity of the water flow was obtained from the rotameter using the following equation:

$$u = \frac{Q}{A} \quad (9)$$

where Q is the volumetric flow rate of fluid, (m^3/h) and A is the bed cross-sectional area, (m^2)

The rotameter valve was opened until the bed was filled with water and the column became free from bubbles. The pressure drop across the bed was measured using U-tube manometer. The friction factor was obtained from the pressure drop using the equation below:

$$f = \frac{e^3(-\Delta p)}{S(1-e)L\rho u^2} \quad (10)$$

4. Test Method

4.1 True Density of Particles

The true densities of particles (ρ_t) were determined using shifted water method. A known weight of particles was immersed in a graduated cylinder filled with water. The weight of the container was measured using a sensitive balance first when the container filled with water only and second when it contains the particles besides the water. In both cases, water level inside the container was carefully maintained at its permissible full mark level. Using the following equation, the true density of particles was determined as [24].

$$\rho_t = \frac{w_1 \times \rho_w}{w_2 - w_3 + w_1} \quad (11)$$

where:

ρ_w is the density of water at laboratory temperature, (g/cm^3).

w_1 is the weight of the particles, (g).

w_2 is the weight of cylinder filled with water, (g).

w_3 is the weight of cylinder with water and particles, (g).

Table 1. The true densities of particles.

Particle size, cm	True density, g/cm ³
1.01	2.5538
0.79	2.5289
0.61	2.5345
0.50	2.5411
0.42	2.4741

Table 1 shows the true densities of the particles. Each measurement was repeated three times for each tested particle to determine the true density value. For mixture of particles, the true density of mixture (ρ_{tm}) was determined from the following equation [8].

$$\rho_{tm} = \frac{1}{\sum_{i=1}^m \frac{x_i}{\rho_{ti}}} \tag{12}$$

where x_i is the weight percent of component i , and ρ_{i} is the true density of component i .

4.2 Bulk density

The bulk density (ρ_b) is defined by the following expression [25]:

$$\rho_b = \frac{\text{Weight of particles comping the bed}}{\text{Volume of bed}} \tag{13}$$

For cylindrical bed

$$\text{Volume} = \frac{\pi}{4} D^2 L \tag{14}$$

5. Results and Discussion

The results of the empirical equations are presented, discussed and compared with experimental results made in the present work, as well as with results taken by using Sawistowski, Carman and Ergun equation for water flow through packed bed.

The friction factor values of water flow through beds of mono sizes particles are plotted versus Reynolds numbers in Figures 4 to 8.

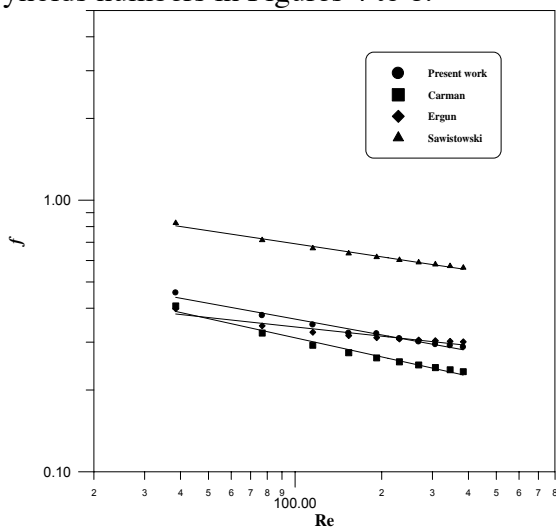

Fig. 4. Friction factor versus Reynolds numbers for particles diameter of 0.42 cm and porosity of 0.3793.

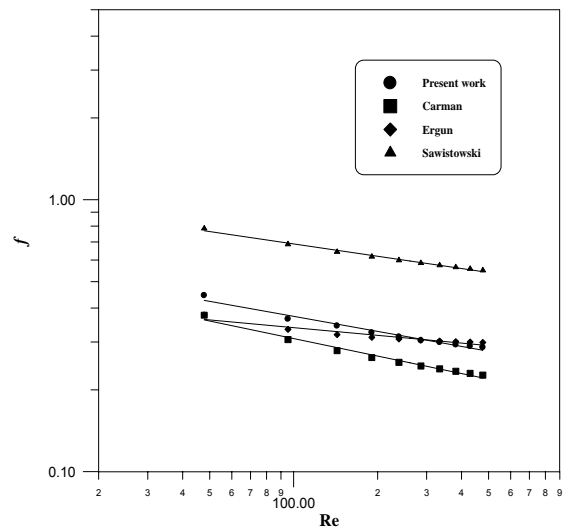

Fig. 5. Friction factor versus Reynolds numbers for particles diameter of 0.51 cm and porosity of 0.4051.

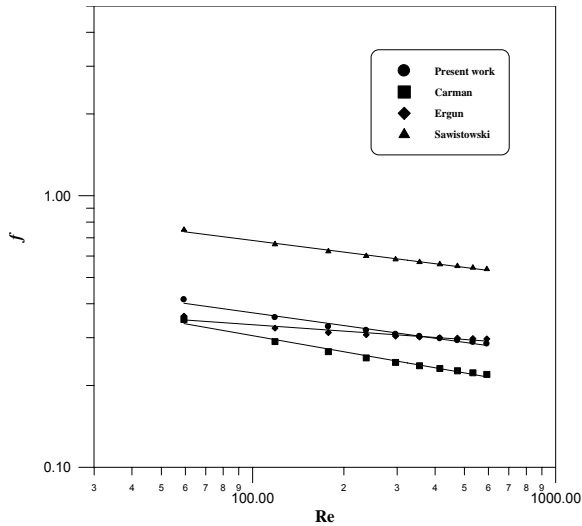

Fig. 6. Friction factor versus Reynolds numbers for particles diameter of 0.61 cm and porosity of 0.4156.

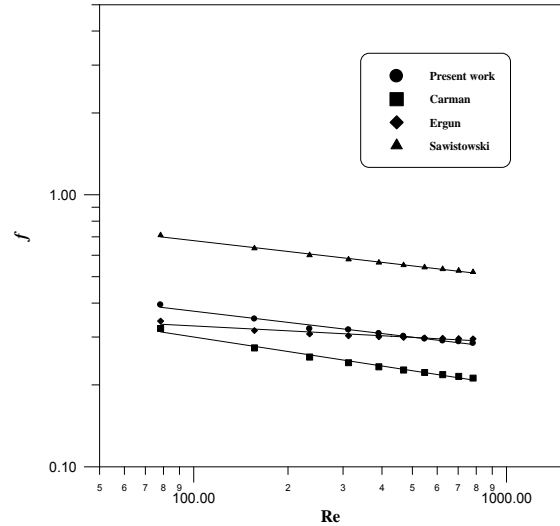

Fig. 7. Friction factor versus Reynolds numbers for particles diameter of 0.79 cm and porosity of 0.4265.

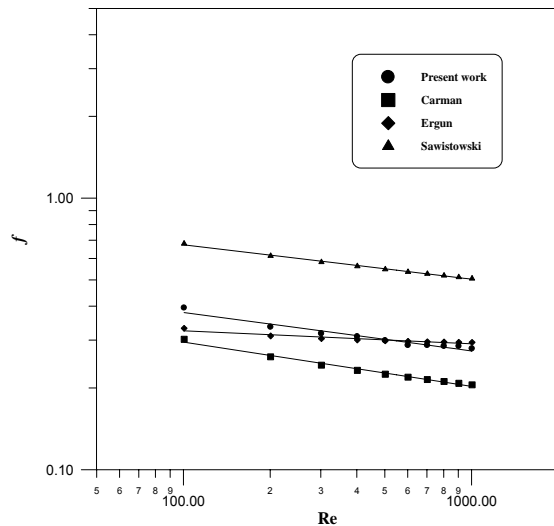

Fig. 8. Friction factor versus Reynolds numbers for particles diameter of 1.01 cm and porosity of 0.4321.

Figures 4 to 8 show that as the particle size increases from 0.42 to 1.01 cm, the bed porosity increase from 0.3793 to 0.4321 and the Reynolds number values increase from the range of 38.5-384.2 in figure 4 to the range of 100.5-1004.0 in figure 8 which lead to decrease in the friction factor values from the range of 0.456-0.288 in figure 4 to the range of 0.394-0.279 in figure 8.

The best fitting of the experimental results for water flow through beds of mono-sizes particles is represented by the following equation.

$$f = 3.51Re_1^{-1} + 0.53Re_1^{-0.1} \tag{15}$$

With the correlation coefficient is 0.97406 and percentage of average errors is 2.44%.

5. Conclusions

The experimental results of friction factor for water flow show linear behavior this is because the range of Reynolds number of water flow is at the turbulent region.

The friction factor values for water flow decrease slightly with increasing Reynolds number values, because the water flow is at the turbulent region where the high rate velocity of fluid behaves as a slip velocity and has insignificant effect on the friction values.

Comparing the experimental results of the present work with those of Sawistowski, Carman and Ergun, it can be noticed that the curves of the present work lie among the results of Sawistowski, Carman and Ergun; this is due to the differences of beds dimensions, packings shapes and sizes.

References

1. Ergun S. (1949), "Fluid Flow through Randomly Packed Columns and Fluidized Beds." Industrial and Engineering Chemistry, Vol. 41, No. 6: pp. 1179-1184.
2. Hjertager B. H., Solbery T., and Hasen K. (2005), "Reactive gas-solids flow in circulating fluidized beds". Fourth International Conference on CFD in the Oil and Gas, Metallurgical & Process Industries SINTEF / NTNU Trondheim, Norway 6-8 June.
3. Moreira E. A. and Coury J. R. (2004), "The Influence of Structural Parameters on the Permeability of Ceramic Foams". Brazilian Journal of Chemical Engineering Vol. 21, No. 01, pp. 23 - 33.
4. Quak. F. L. and Chad P. B. (2005), "The effect of particle size distribution on pressure drop through packed beds of cooked wood chips". The Canadian Journal of Chemical Engineering, Vol. 83, No. 8, pp.755-763.
5. Leva M., Weintraub M., Grummer M., Pollchik M. and Sforch H. H., "Fluid Flow through Packed and Fluidized Systems". United States Government Printing Office, Washington, 1951.
6. Carman P. C., " Fluid flow through a granular bed". Trans. Inst. Chem. Eng, 15 (1937) 153.
7. Kozeny J., Ber, Wien Akad, 136 (1927) 271.
8. Coulson J. M., Inst. Chem. Eng, 13 (1949) 237.
9. Blank F. C., Trans. Amer. Inst. Chem, 14 (1962) 415.
10. Green J. and Ampt J., Agric. Sci, 13 (1962) 5.
11. Hellström J. G. I. and Lundström T. S., " Flow through Porous Media at Moderate Reynolds Number", International Scientific Colloquium Modeling for Material Processing, Riga, June 8-9, 2006.
12. Furnas C. C., Ind. Eng. Chem, 23 (1931) 1052.
13. Westman A. E. and Hugill M. R., J. Am. Ceram. Soc, 13 (1930) 767.
14. Basu S., Dixon C., Fereday C., Mueche A., and Perry T., "Comparison of the Ergun equation with experimental values regarding pressure drop and fluid velocity", The Canadian Journal of Chemical Engineering, Vol. 81, No. 2, 2003.
15. Suter S. P. and Skalak R., "The history of Poiseuille's law, "Annual Review of Fluid Mechanics, Vol. 25, 1993, pp. 1-19.
16. Foust A. S., Wenzel L. A., C. W. Clump, L. Maus, and L. B. Andersen, "Principles of Unit Operations", Second Edition, John Wiley and Sons, New York, 1980.
17. Orning A. A., Ind. Eng. Chem, 41 (1949) 1179.
18. Lewis W. K. and Bauer W. C., Ind. Chem. Eng, 42 (1949) 1111.
19. Coulson J. M. and Richardson J.F., "Chemical Engineering", volume II, Third Edition, Pergamon Press, London, 1985.
20. Sawistowski H., Chem. Eng. Sci, 6 (1957) 138.
21. Ergun S., Chem. Eng. Prog, 48 (1952) 89.
22. Perry R. H., Green D. W., and Maloney J. O., "Perry's Chemical Engineers Handbook", Seventh Edition, McGraw-Hill, New York, 1997.

23. Standish N., and Mellor D. G., Powder technology, 27 (1980) 61.
24. Al-Dulami B. O., M. SC. Thesis, "Porosity of particle mixture using RRSB size distribution", Al-Nahrain University, 1998.
25. McCabe W. L., Smith J. C., and Peter Harriott, "Unit Operation of Chemical Engineering", Sixth Edition, McGraw-Hill, new York, 2001.

Notation

<i>Symbols</i>	<i>Notation</i>
K''	= Kozeny constant
Δp	= Pressure drop through packed bed (kg/m.s ²)
u	= Superficial velocity (m/s)
L	= The height of packing in the bed (m)
Q	= Flow rate (m ³ /hr)
S	= Specific surface area of the particles (m ² /m ³)
S_B	= Specific surface area of the bed (m ² /m ³)
A	= The bed cross-sectional area (m ²)
d_p	= Diameter of the particle (m)
d_{pav}	= Average particles size (m)
d_{pi}	= Diameter of particle i in mixture (m)
D	= Diameter of cylinder (m)
Re_1	= Modified Reynolds number
e	= Porosity of the bed
$\frac{R_1}{\rho u_1^2}$	= Modified friction factor
u_1	= Average velocity through the pore channels (m/s).
L'	= Length of channel (m)
d_m	= Equivalent diameter of the pore channels (m)
K'	= Is a dimensionless constant whose value depends on the structure of the bed
X_i	= The proportion of the component i in the mixture
x_i	= The weight fraction of particle i

f_w	=	Correction factor
S_c	=	Surface of the container per unit volume of bed (m^{-1})
d_t	=	Diameter of tube (m)
f	=	Modified friction factor
q	=	Number of components in the mixture
a	=	Representation of packing and fluid characteristics at laminar flow
b	=	Representation of packing and fluid characteristics at turbulent flow

Greek Symbols

ϵ	=	Porosity of the bed
ρ_b	=	Bulk density (g/cm^3)
ρ_t	=	True density (g/cm^3)
ρ_{tm}	=	True density of mixture (g/cm^3)
ρ_{ti}	=	True density of component i
ρ	=	Density of fluid (kg/m^3)
μ	=	Fluid viscosity ($kg/m.s$)
\emptyset_s	=	Sphericity
δ	=	orientation factor
θ	=	angle of the solid liquid interface with the stream direction